

THE PANEL 2



Pannello LED con cornice in lega di alluminio verniciata a polvere di colore bianco, diffusore opale in PMMA resistente ai raggi UV.

UGR<19 4H-8H, S=0,25, indice di riflessione 70-50-20.

Versione 600x600 mm installabile ad incasso su controsoffitto a pannelli 600x600 mm con struttura a vista senza accessori, per le altre installazioni prevedere gli opportuni accessori da ordinare a parte. Alimentatore elettronico incluso.

LED panel with frame made of white powder coated aluminium alloy, opal diffuser in PMMA, UV resistant. UGR<19 4H-8H, S=0,25, reflexion index 70-50-20.

No accessories needed for installation on 600x600 mm visible-structure ceiling, accessories for other installations to be ordered separately. Integrated electronic driver.

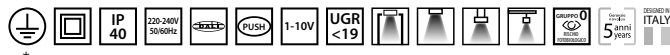

* Solo versione DALI/PUSH/1-10V

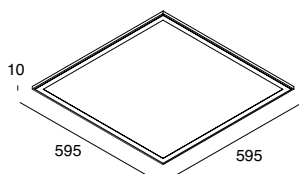

THE PANEL 2
600x600

POWER	FLUX	3000K	FLUX	4000K
35W	3343 lm	<input type="checkbox"/> 102001.01	3447 lm	<input type="checkbox"/> 102002.01

DALI-PUSH-1-10V

POWER	FLUX	3000K	FLUX	4000K
35W	3343 lm	<input type="checkbox"/> 102035.01	3447 lm	<input type="checkbox"/> 102036.01

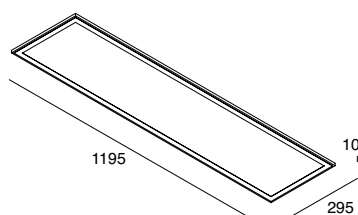

THE PANEL 2
1200x300

POWER	FLUX	3000K	FLUX	4000K
35W	3343 lm	<input type="checkbox"/> 102007.01	3447 lm	<input type="checkbox"/> 102008.01

DALI-PUSH-1-10V

POWER	FLUX	3000K	FLUX	4000K
35W	3343 lm	<input type="checkbox"/> 102037.01	3447 lm	<input type="checkbox"/> 102038.01

THE PANEL 2 MICROPRISMATICO



IL PRODOTTO RISPONDEnte AI REQUISITI PER EDIFICI PUBBLICI
D.M. 11 OTT 2017 (C.A.M. Edilizia)

THE PRODUCT COMPLIES WITH THE REQUIREMENTS FOR
PUBLIC BUILDINGS, MINISTERIAL DECREE OF 11th OCT 2017

Pannello LED con cornice in lega di alluminio verniciata a polvere di colore bianco, diffusore microprismatico UGR<19 in PMMA resistente ai raggi UV.

Versione 600x600 mm installabile ad incasso su controsoffitto a pannelli 600x600 mm con struttura a vista senza accessori, per le altre installazioni prevedere gli opportuni accessori da ordinare a parte. Alimentatore elettronico incluso.

LED panel with frame made of white powder coated aluminium alloy, micro-prismatic diffuser UGR<19 in PMMA, UV resistant.

No accessories needed for installation on 600x600 mm visible-structure ceiling, accessories for other installations to be ordered separately. Integrated electronic driver.

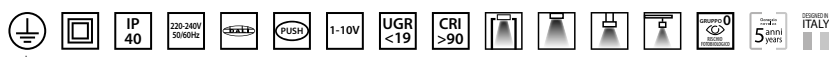

* Solo versione DALI/PUSH/1-10V

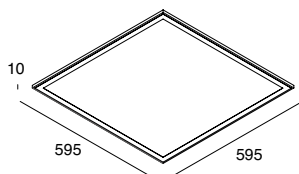

THE PANEL 2
MICROPRISMATICO
600x600

POWER	FLUX	3000K	FLUX	4000K
32W	3386 lm	<input type="checkbox"/> 102043.01	3490 lm	<input type="checkbox"/> 102044.01

DALI-PUSH-1-10V

POWER	FLUX	3000K	FLUX	4000K
32W	3386 lm	<input type="checkbox"/> 102045.01	3490 lm	<input type="checkbox"/> 102046.01

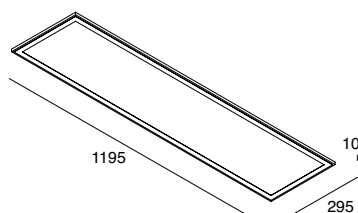

THE PANEL 2
MICROPRISMATICO
1200x300

POWER	FLUX	3000K	FLUX	4000K
32W	3386 lm	<input type="checkbox"/> 102047.01	3490 lm	<input type="checkbox"/> 102048.01

DALI-PUSH-1-10V

POWER	FLUX	3000K	FLUX	4000K
32W	3386 lm	<input type="checkbox"/> 102049.01	3490 lm	<input type="checkbox"/> 102050.01

THE PANEL 2

ACCESSORI PER INSTALLAZIONE AD INCASSO ACCESSORIES FOR RECESSED MOUNTED

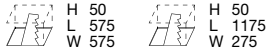
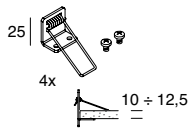

KIT MOLLE PER INSTALLAZIONE AD INCASSO
Per versioni 600x600 e 1200x300, per installazione in battuta in cartongesso di spessore 10-12,5 mm.

SPRINGS KIT FOR RECESSED INSTALLATION
For 600x600 and 1200x300 versions, for installation by frame contrasting in plasterboard of thickness 10-12,5 mm.

CODE

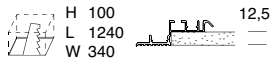
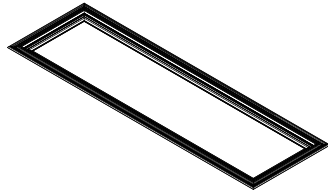
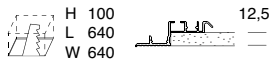
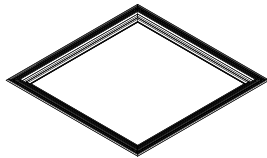
16215.99

KIT PER INSTALLAZIONE AD INCASSO A RASAMENTO

Profilo da rasare su cartongesso di spessore 12,5 mm.
Il pannello si installa in appoggio

KIT FOR LEVELLED RECESSED INSTALLATION
Profile to be levelled on 12,5 mm thick plasterboard.

CODE

VERSION

102028.99

600x600

102029.99

1200x300

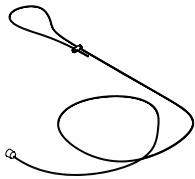

KIT ANTICADUTA
Cavo in acciaio da fissare a soffitto o strutture tramite morsetto in ottone nichelato e aggancio a vite sul pannello.

ANTI FALL-OUT KIT
Steel cable to be fixed to the ceiling or structures using a nickel-plated brass clamp and screwed on the panel.

CODE

L (mm)

102031.99

3000

Per accessori di installazione su controsoffitti a struttura nascosta, contattare l'ufficio tecnico Novalux.
For installation accessories on concealed grid ceilings, please contact Novalux technical office.

THE PANEL 2

ACCESSORI PER INSTALLAZIONE A PLAFONE ACCESSORIES FOR CEILING MOUNTED

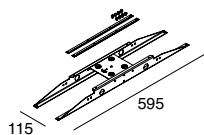

KIT PER INSTALLAZIONE A PLAFONE
Per versioni 600x600 e 1200x300, non installabile a parete o in fila continua.
Distanza tra prodotto e soffitto 40 mm.

CODE

16213.99

KIT FOR CEILING MOUNTING
For 600x600 and 1200x300 versions,
not suitable for wall surface or
continuous line installation.
Distance between the fixture and the
ceiling 40 mm.

CODE

102033.01

VERSION

600x600

102034.01

1200x300

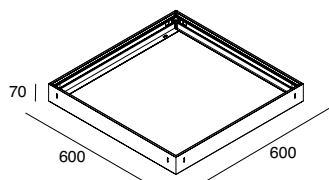

**BOX PER INSTALLAZIONE A PLAFONE
600X600**
Kit da assemblare, non installabile a parete.
Idoneo per l'alloggiamento del kit di
emergenza (102025.99/102026.99).

CODE

102033.01

VERSION

600x600

102034.01

1200x300

KIT FOR CEILING MOUNTING 600x600
To be assembled, not suitable for wall
surface mounting.
Suitable for emergency kit
(102025.99/102026.99).

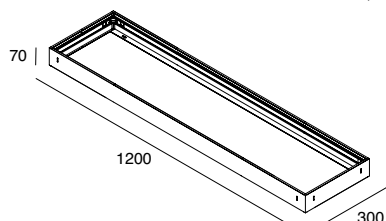

**BOX DECORATIVO PER INSTALLAZIONE
A PLAFONE**
Superficie esterna verniciata bianca o nera,
interno bianco. Non installabile a parete
Non idoneo per l'alloggiamento del kit di
emergenza.

CODE

102051.01

VERSION

.02 600x600

102052.01

.02 1200x300

**DECORATIVE BOX FOR CEILING
MOUNTING**
External surface white or black painted,
internal white. Not suitable for wall surface
mounting.
Not suitable for emergency kit .

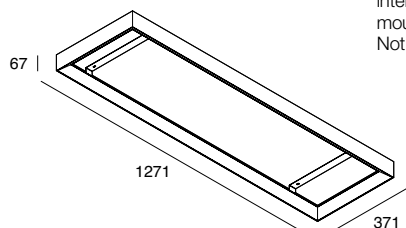
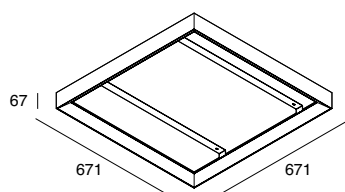

THE PANEL 2

ACCESSORI PER INSTALLAZIONE A SOSPENSIONE ACCESSORIES FOR SUSPENSION MOUNTED

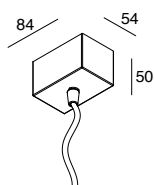

KIT DI ALIMENTAZIONE

POWER SUPPLY KIT

CODE	L (mm)	Cavo / Cable (mm ²)
12120.01	1200	3x1,5
12121.01	3000	3x1,5
12122.01	1200	5x1,5
12123.01	3000	5x1,5

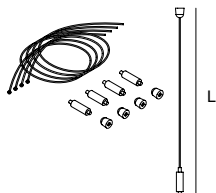

KIT n.4 SOSPENSIONI
per versioni 600x600 e 1200x300.

KIT nos.4 SUSPENSIONS
for 600x600 and 1200x300 versions.

CODE	L (mm)
16223.99	3000

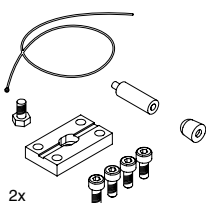

KIT n.2 GIUNTI + SOSPENSIONI
per versioni 600x600 e 1200x300.

KIT nos.2 JOINTS + SUSPENSIONS
for 600x600 and 1200x300 versions.

CODE	L (mm)
16227.96	3000

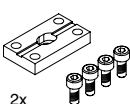

KIT n.2 GIUNTI (privi di sospensioni)
per versioni 600x600 e 1200x300.

KIT nos.2 JOINTS (without suspensions)
for 600x600 and 1200x300 versions.

CODE	L (mm)
16232.96	

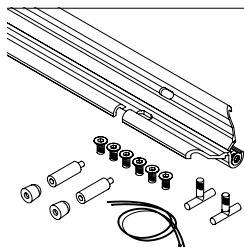

KIT SNODO + n.2 SOSPENSIONI
per versione 600x600
profilo in lega di alluminio verniciato.

KIT HINGE + nos.2 SUSPENSIONS
for 600x600 version
profile in powder coated aluminium alloy.

CODE	L (mm)
16228.01	3000

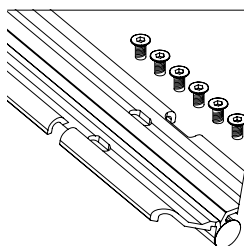

KIT SNODO (privo di sospensioni)
per versione 1200x300
profilo in lega di alluminio verniciato.

KIT HINGE (without suspensions)
for 1200x300 version
profile in powder coated aluminium alloy.

CODE	L (mm)
16234.01	

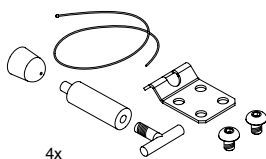

KIT n.4 SOSPENSIONI INCLINATE
per versioni 600x600 e 1200x300

KIT nos.4 INCLINED SUSPENSIONS
for 600x600 and 1200x300 versions

CODE	L (mm)
16230.99	3000

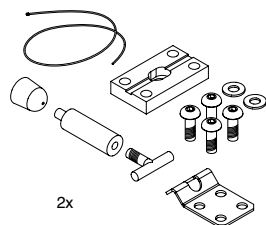

KIT n.2 GIUNTI + SOSPENSIONI +
STAFFE INCLINATE
per versione 600x600.

KIT nos.2 JOINTS + SUSPENSIONS +
INCLINED BRACKETS
for 600x600 version.

CODE	L (mm)
16231.96	3000

THE PANEL 2

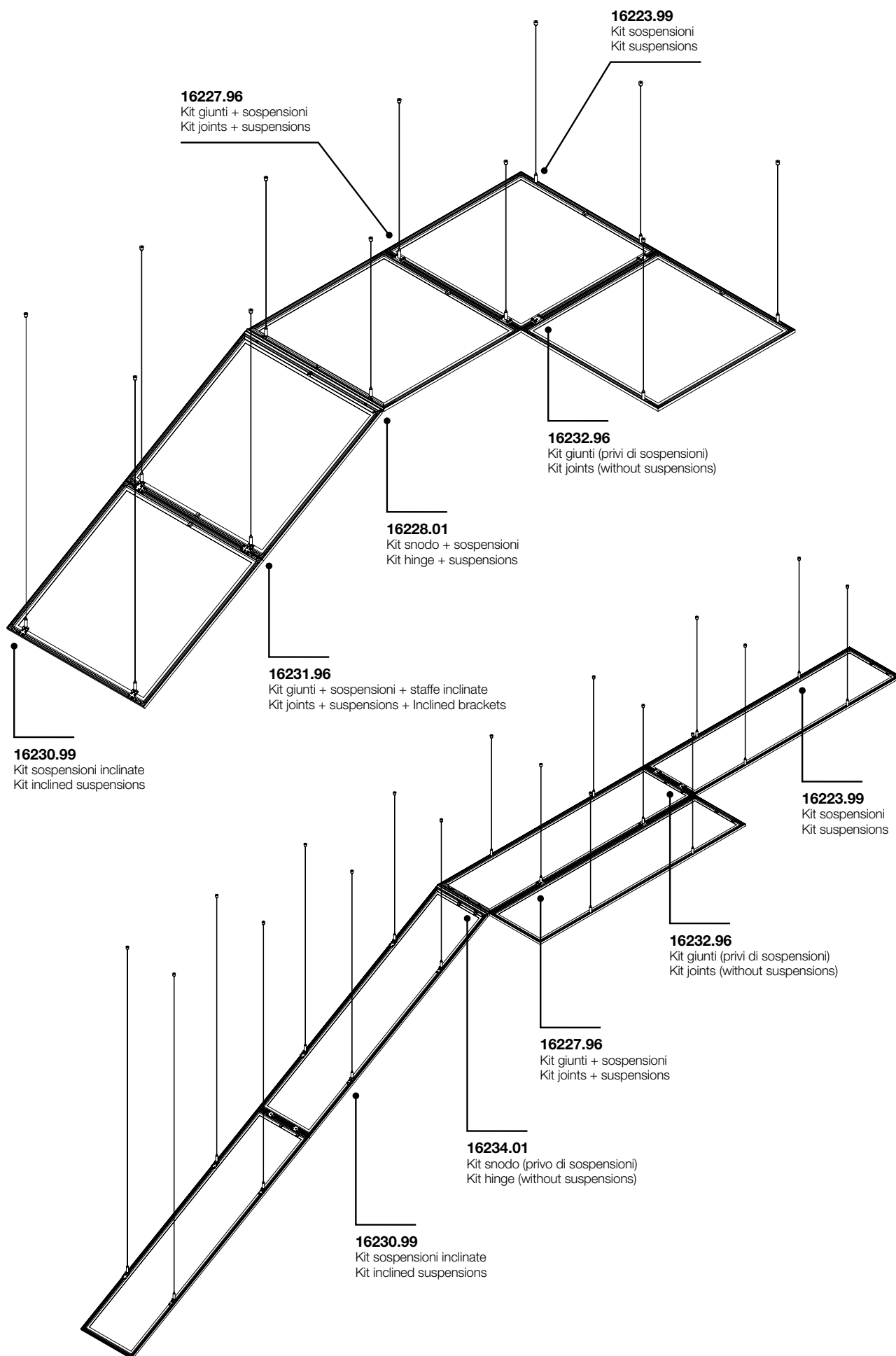
COMPOSIZIONI SOPPESE
SUSPENDED COMPOSITIONS

THE PANEL 2

ACCESSORI PER INSTALLAZIONE A BINARIO ACCESSORIES FOR TRACK MOUNTED

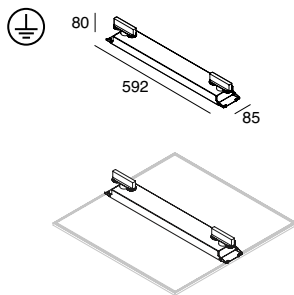

KIT BINARIO 600x600
completo di 2 adattatori
(elettrico/meccanico)
per binario elettrificato All-Track.

KIT FOR TRACK MOUNTING 600x600
supplied with 2 adaptors
(electrical/mechanical)
for electrified All-Track.

CODE	VERSION
102055.01	3P+DALI
102053.01	3P

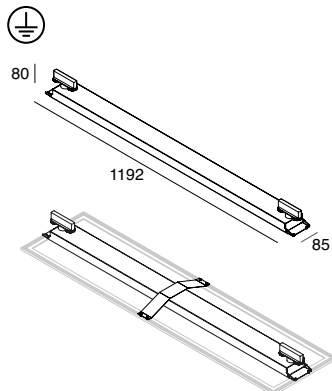

KIT BINARIO 1200x300
completo di 2 adattatori
(elettrico/meccanico)
per binario elettrificato All-Track.

KIT FOR TRACK MOUNTING 1200x300
supplied with 2 adaptors
(electrical/mechanical)
for electrified All-Track.

CODE	VERSION
102056.01	3P+DALI
102054.01	3P

THE PANEL 2

ACCESSORI EMERGENZA ACCESSORIES EMERGENCY

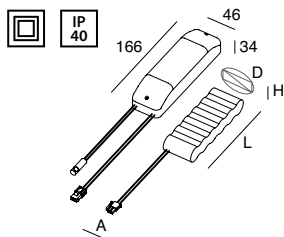

KIT DI ALIMENTAZIONE IN EMERGENZA
Per versioni 600x600 e 1200x300, per
installazione ad incasso o a plafone con Box
(102033.01, 102034.01).
Completo di connettori polarizzati per il
collegamento dell'alimentatore.

KIT FOR EMERGENCY
For 600x600 and 1200x300 versions,
for recessed installation or ceiling installation
with Box (102033.01, 102034.01)
Polarized connectors included.

CODE	TIME	A (mm)	D (mm)	H (mm)	L (mm)
102025.99	1h	46	59	23	138
102026.99	3h	80	92	44,5	212

Flusso in emergenza
Emergency flux

THE PANEL 35W 17%

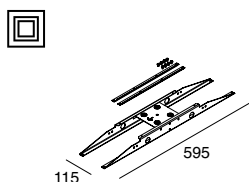

KIT PER FISSAGGIO A PLAFONE /
SOSPENSIONE + KIT EMERGENZA
Per versioni 600x600 e 1200x300, non
installabile a parete o in fila continua.
Kit con emergenza 1h integrata.
Distanza tra prodotto e soffitto 40 mm.

KIT FOR CEILING MOUNTING / SUSPENDING
+ EMERGENCY 1H
For 600x600 and 1200x300 versions,
not suitable for wall surface or continuous line
installation. 1h emergency kit integrated.
Distance between the fixture and the ceiling 40
mm.

CODE	VERSION
16222.99	1h

Flusso in emergenza
Emergency flux

THE PANEL 35W 17%