

MATERIALS

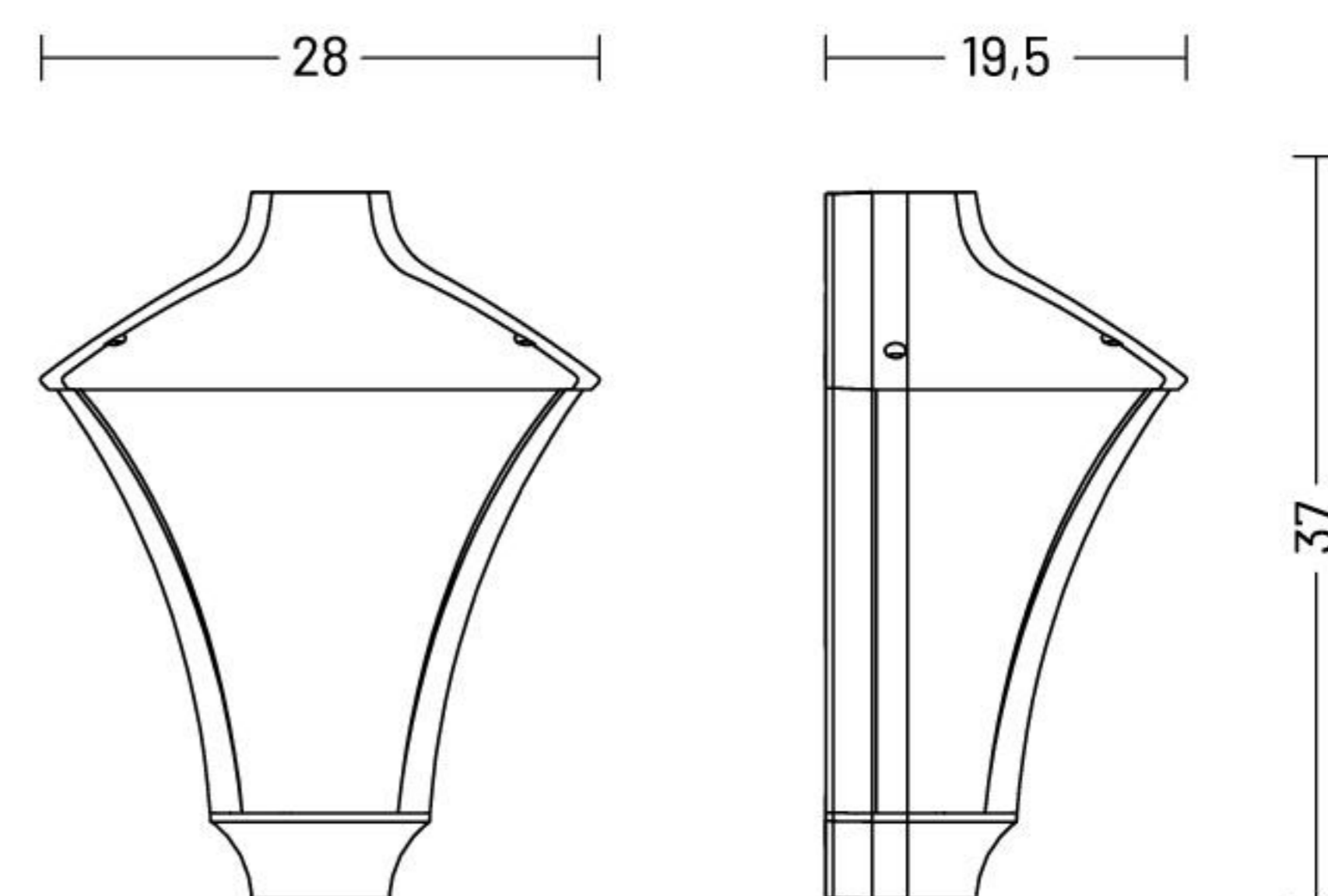





<i>Body</i>	Die-cast aluminium EN47100
<i>Diffuser</i>	Extra clear or opal polycarbonate
<i>Finishing</i>	Polyester powder paint



ORDER CODE

MO 3 _ PAR D _ B 10 _

Finishing

G	Black	
S	Black/copper	
P	Black/green	
R	Black/silver	
L	Graphite	
V	Oxide	

Light colour

N	4000 K
H	3000 K

Diffuser

0	Extra clear
3	Opal

Example

MO 3 0 PAR D N B 10 L

