

Gypsum Cell | Downlights | powerLED 4 W 350 mA

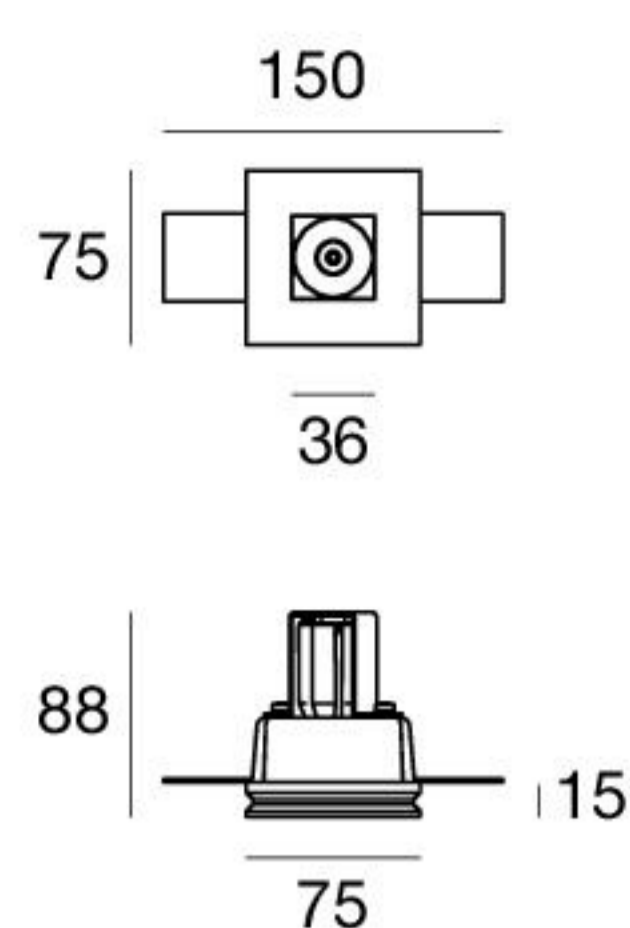
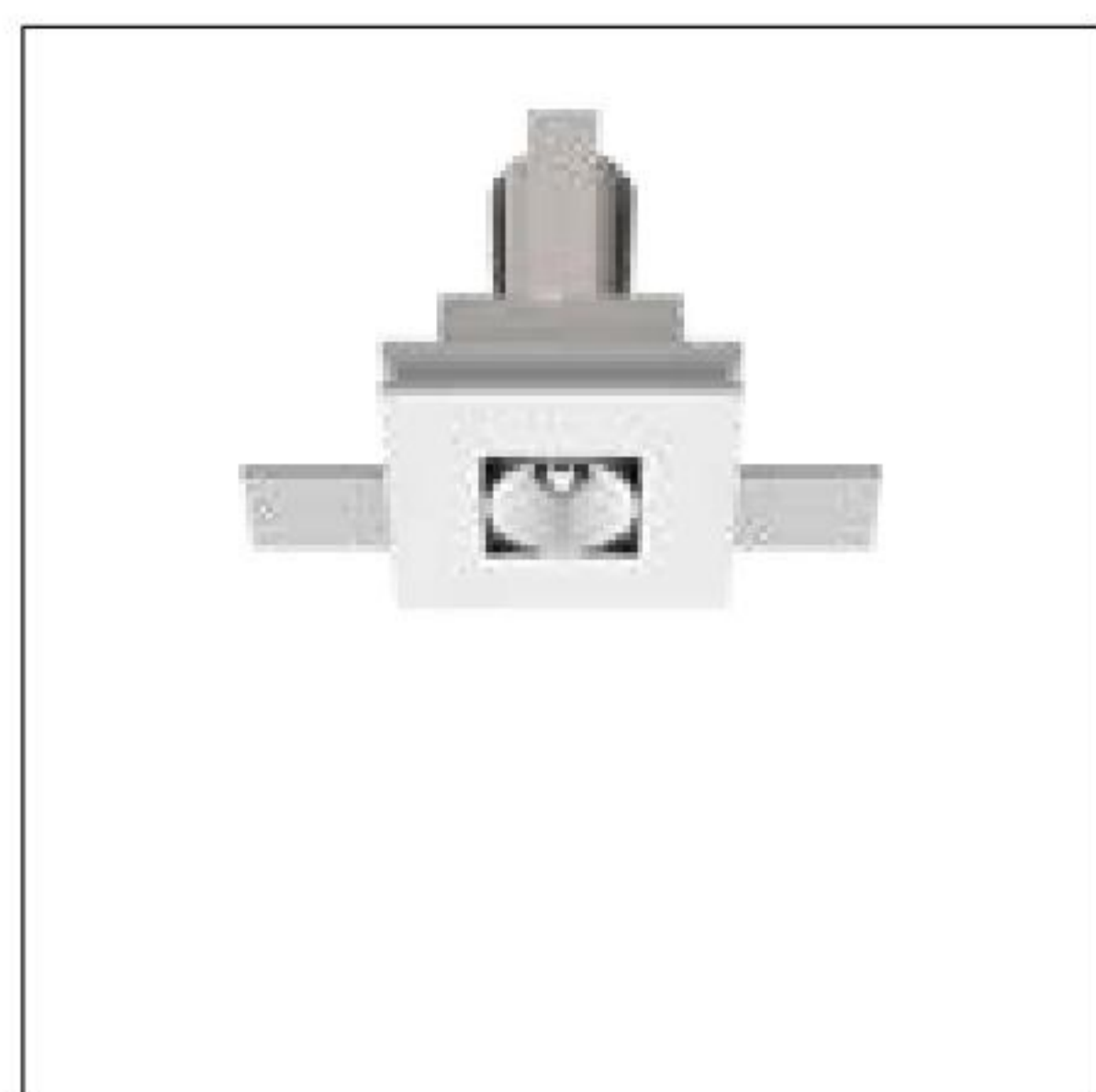
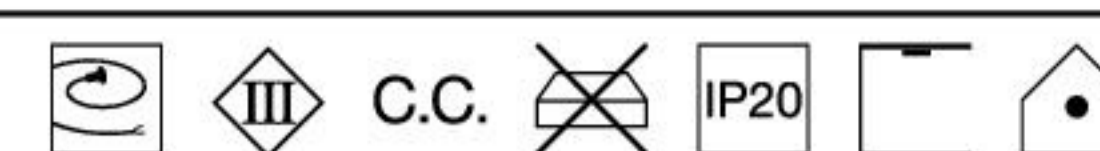

CRI 80

White	64632	2700 K	490 lm	M	Spot	15
Black	64633	3000 K	490 lm	W	Medium Flood	30
		4000 K	529 lm	N	Flood	45

Electronics

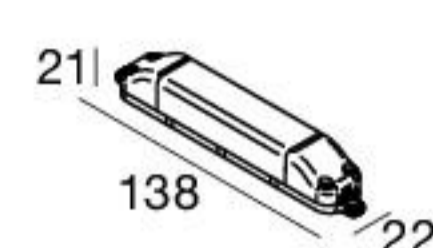

89145
ON/OFF
1 art.

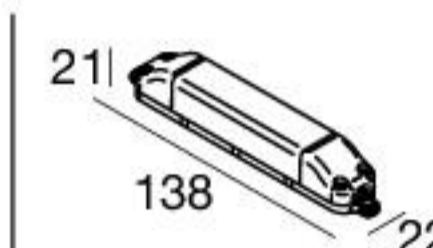

99708
0/1-10V converter
1 art.

+ driver CV 24V

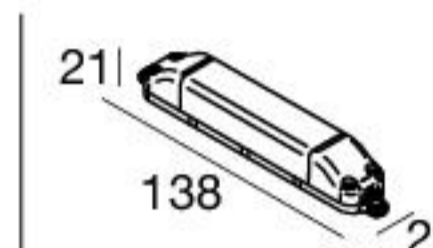

99711
DALI converter
1 art.

+ driver CV 24V



Gypsum Cell | Downlights | 3 x powerLEDs 4 W | 12 W 350 mA

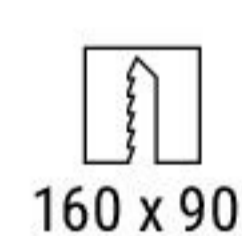
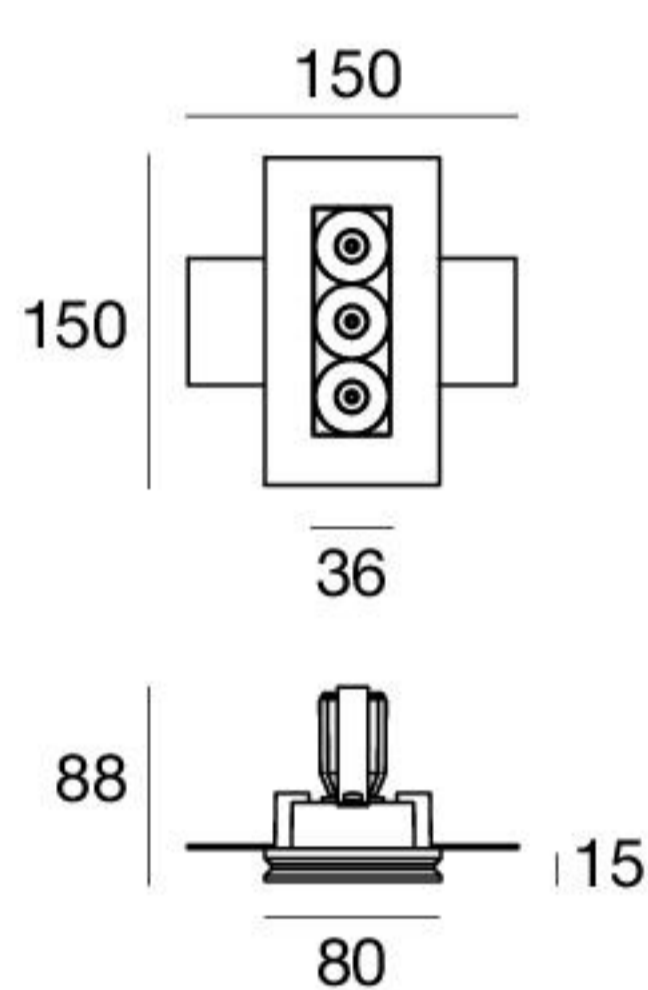
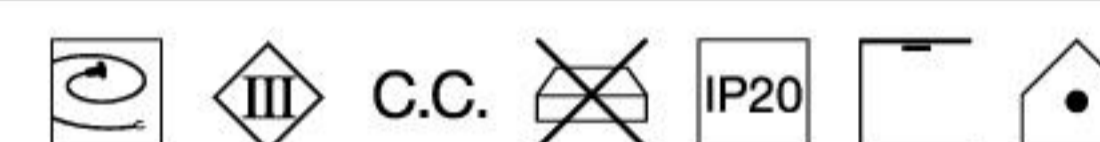

CRI 80

White	64637	2700 K	1470 lm	M	Spot	15
Black	64638	3000 K	1470 lm	W	Medium Flood	30
		4000 K	1587 lm	N	Flood	45

Electronics

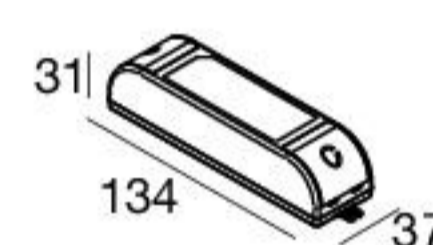

99126
ON/OFF
1 art.

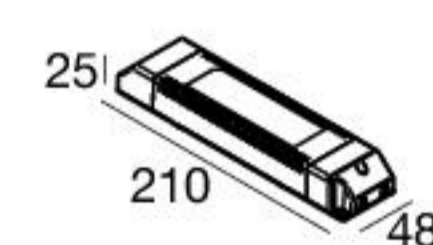

99115
0/1-10V
1 art.

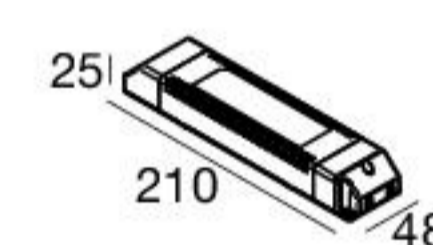

99344
DALI
1 art.



Accessories

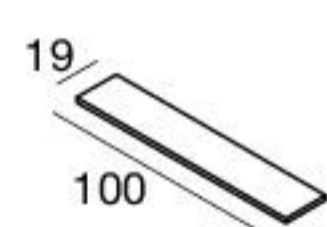

Spacer

60830

100x19 mm

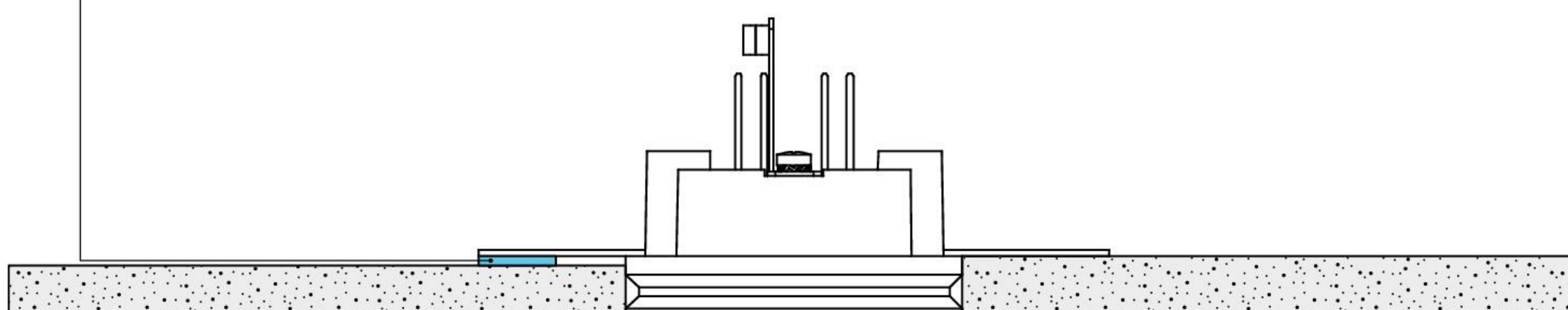

STANDARD THICKNESS = 13 mm

SPECIAL THICKNESS ≤ 15 mm