

KONE

CON RIFLETTORE COLORATO INTERCAMBIABILE

WITH INTERCHANGEABLE COLOURED OPTIC



Rame lucido
Shiny copper

Oro opaco
Matt gold

Ottone satinato
Satin brass

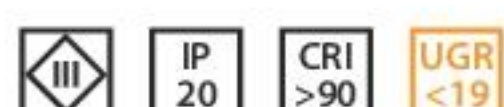

Versione con riflettore colorato intercambiabile.
Corpo e dissipatore in lega di alluminio verniciata.
Molle in acciaio armonico per fissaggio su controsoffitto.
Alimentatore elettronico 350mA o 500mA da ordinare a parte.

Version with interchangeable coloured optic.
Body and dissipater made of painted aluminium alloy.
Clips for fixing to the false ceiling made of harmonic steel.
Electronic driver 350mA or 500mA to be ordered separately.

KONE 7W 350mA

Con riflettore brunito intercambiabile.
Idoneo per controsoffitto di spessore da 5 a 20 mm.

With interchangeable burnished optic.
False ceiling thickness 5-20 mm.



POWER	BEAM	FLUX	3000K	FLUX	4000K
7W	36°	500 lm	103609.04	526 lm	103610.04

RIFLETTORI COLORATI COLOURED OPTICS

FINISH	3000K	4000K	CODE
Rame lucido - Shiny copper	524 lm	552 lm	103612.14
Oro opaco - Matt gold	502 lm	528 lm	103612.15
Ottone satinato - Satin brass	511 lm	538 lm	103612.16

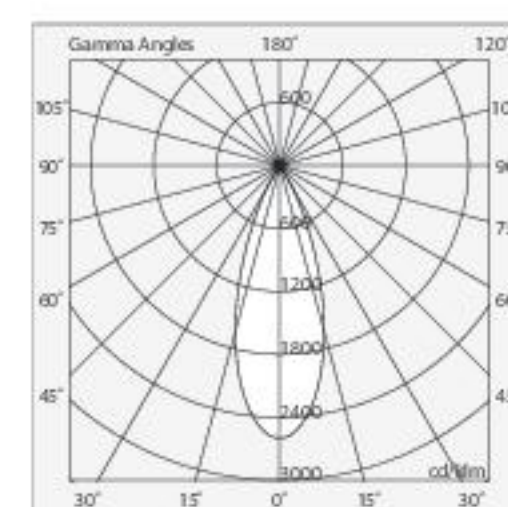
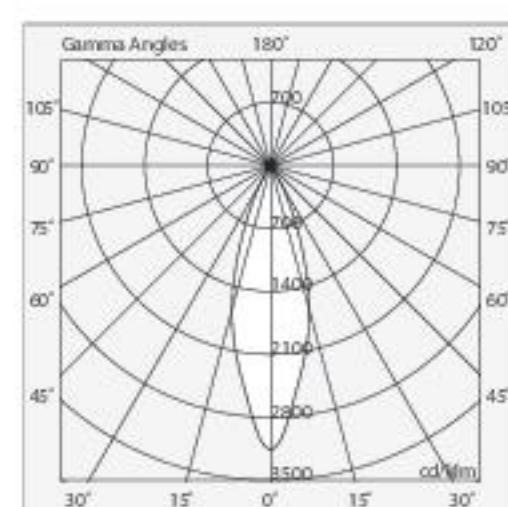
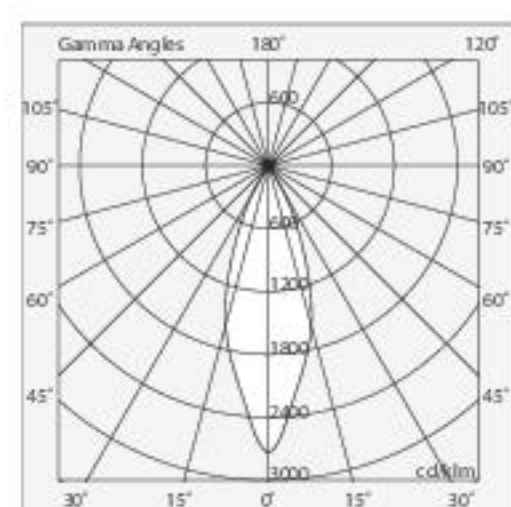

Rame lucido / Shiny copper

Oro opaco / Matt gold

Ottone satinato / Satin brass

KONE 10W 500mA

Con riflettore brunito intercambiabile.
Idoneo per controsoffitto di spessore da 5 a 30 mm.

With interchangeable burnished optic.
False ceiling thickness 5-30 mm.

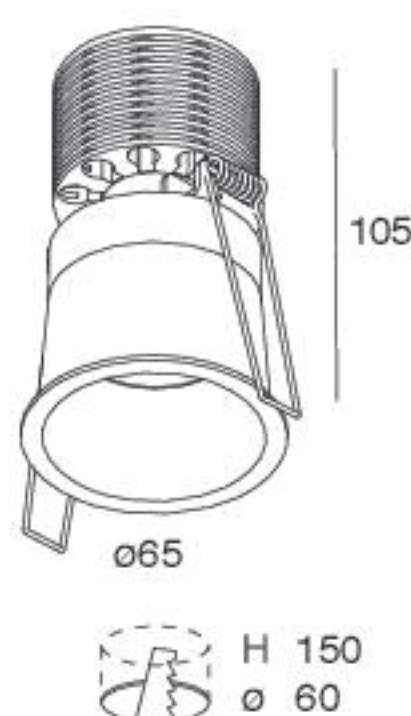

POWER	BEAM	FLUX	3000K	FLUX	4000K
10W	36°	681 lm	103607.04	737 lm	103608.04

RIFLETTORI COLORATI COLOURED OPTICS

FINISH	3000K	4000K	CODE
Rame lucido - Shiny copper	730 lm	790 lm	103611.14
Oro opaco - Matt gold	664 lm	718 lm	103611.15
Ottone satinato - Satin brass	682 lm	738 lm	103611.16

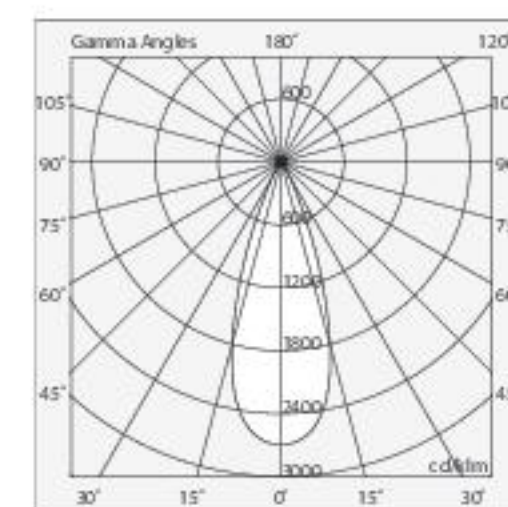
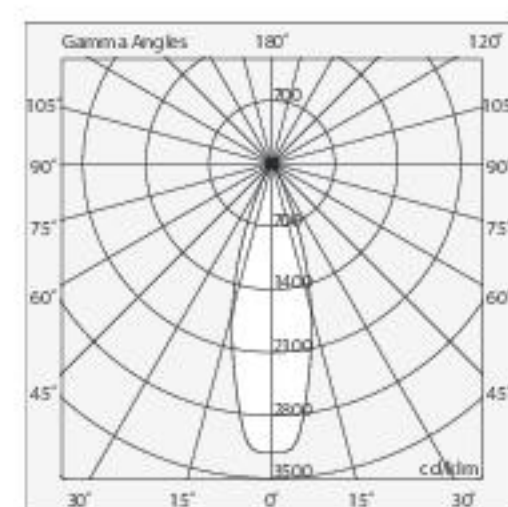
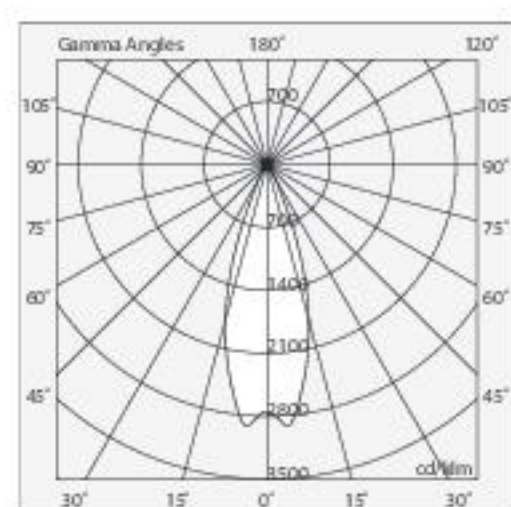

Rame lucido / Shiny copper

Oro opaco / Matt gold

Ottone satinato / Satin brass