

# Fylo Curved

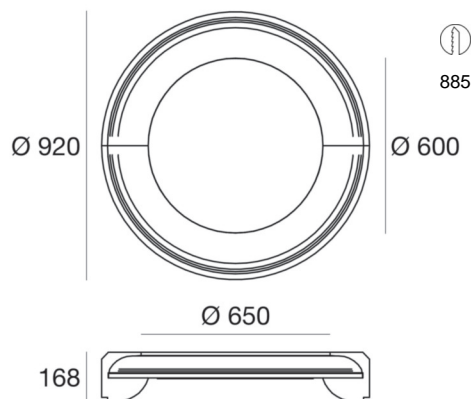

Lines  
60841



Technical data	
Collection	tråddel
Installation position	Ceiling
Installation environment	Indoor
IP	IP20
Glow wire test	650°
Direct mounting on normally flammable surfaces	Yes
CE	Yes
ETL	Yes
Induzione	No
Emergency mode	No
Motion sensor	No
Directional	No
Tilting	No
Walk-over	No
Drive-over	No
Cable included	No
Resin potting	No



Lines  
**60841**

Single emission lines for indoor application.

The ingress protection degree is IP20; the total weight is of 3.6000 kg.

and can be ceiling-mounted, with a 885 mm diameter hole (in plasterboard) with an outer casing, code 62900(for concrete or masonry).

## Components

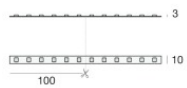

Dropper - LED Strip | stripLED 72 W 24 V

**Code**  
98025

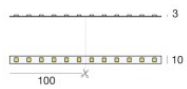

Dropper - LED Strip | stripLED 72 W 24 V

**Code**  
98091

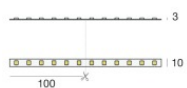

Dropper - LED Strip | stripLED 72 W 24 V

**Code**  
98566

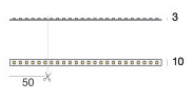

Dropper - LED Strip | stripLED 48 W 24 V

**Code**  
98572

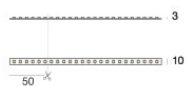

Dropper - LED Strip | stripLED 48 W 24 V

**Code**  
98574



60841

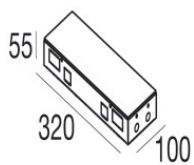

Controcassa  
L=320mm, H=55mm, D=100mm

**Code**

62900